

1	D. Rubin	Mat							
	BYE	BYE							
9	H. Gordon	Mar	63	1	D. Rubin	Mat (dec 5)			56
7									
8	R. Wolf	J 2							
5	B. Frothingham	Hol							
8									
12	D. Beninato	CN							
13	J. Way	K	64	5	B. Frothingham	Hol (dec 5)			
8.1									
4	E. Boschino	Berk							
3	L. Clark	RB							
	BYE	BYE							
11	P. Cowan	LB	65	3	L. Clark	RB (Fal 7)			
9									
6	J. Lauria	Rum							
7	J. Brackett	Ha 2							
10									
10	L. Jagers	By 2							
	BYE	BYE							
2	G. Poniros	Oc	66	2	G. Poniros	Oc (dec 5)			
	BYE	BYE							
8	R. Wolf	J 2							
8	R. Wolf	J 2 (b 1)							
154									
7	J. Brackett	Ha 2							
6	J. Lauria	Rum	234	6	J. Lauria	Rum (dec 4)			
155									
12	D. Beninato	CN (MD 2)							
12	D. Beninato	CN							
13	J. Way	K							
	BYE	BYE							
11	P. Cowan	LB							
11	P. Cowan	LB (b 0)							
156									
4	E. Boschino	Berk (dec 1)							
4	E. Boschino	Berk							
9	H. Gordon	Mar	235	4	E. Boschino	Berk (dec 4)			
157									
9	H. Gordon	Mar (for 3)							
10	L. Jagers	By 2 (b 0)							
10	L. Jagers	By 2							
	BYE	BYE							

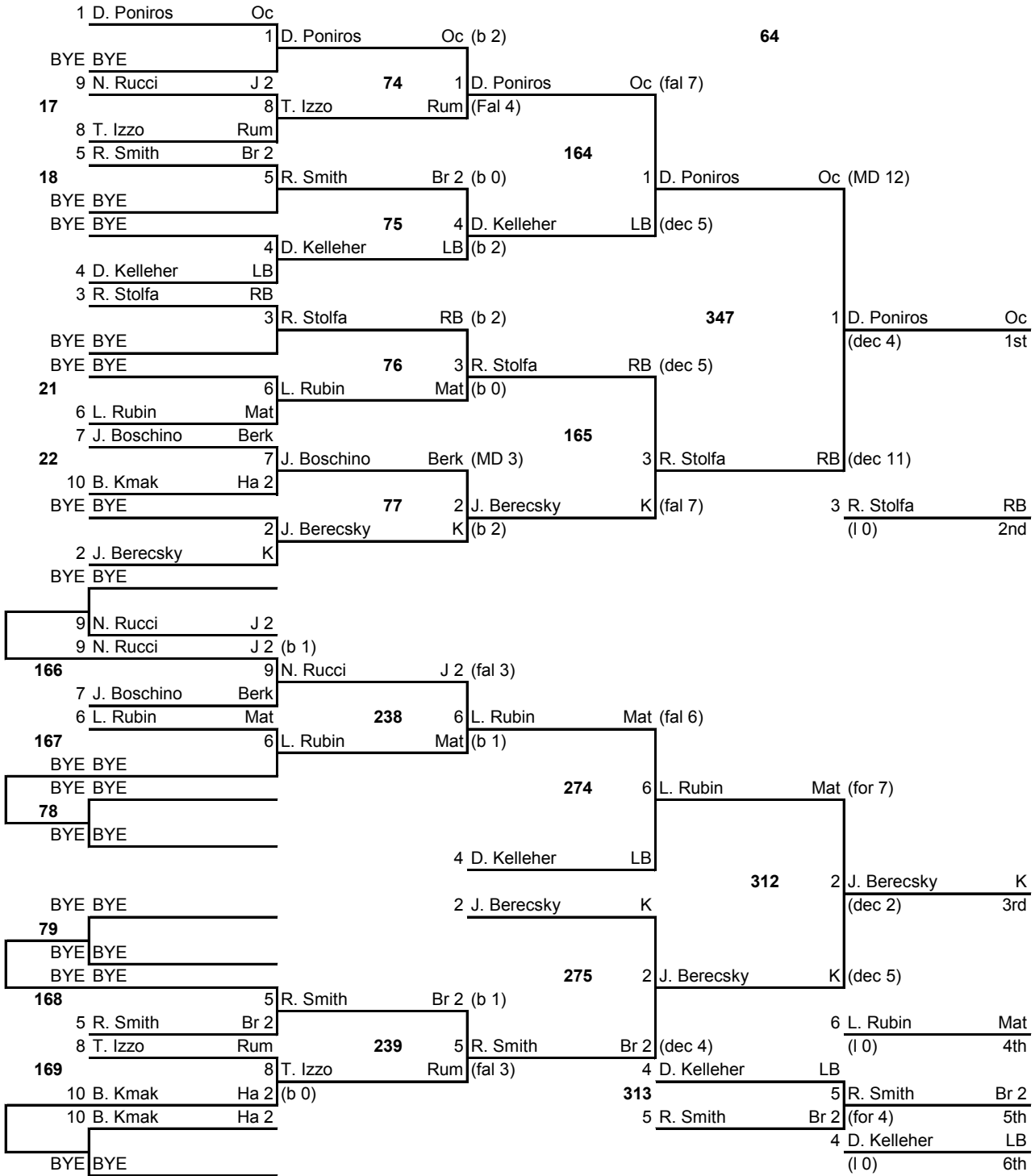

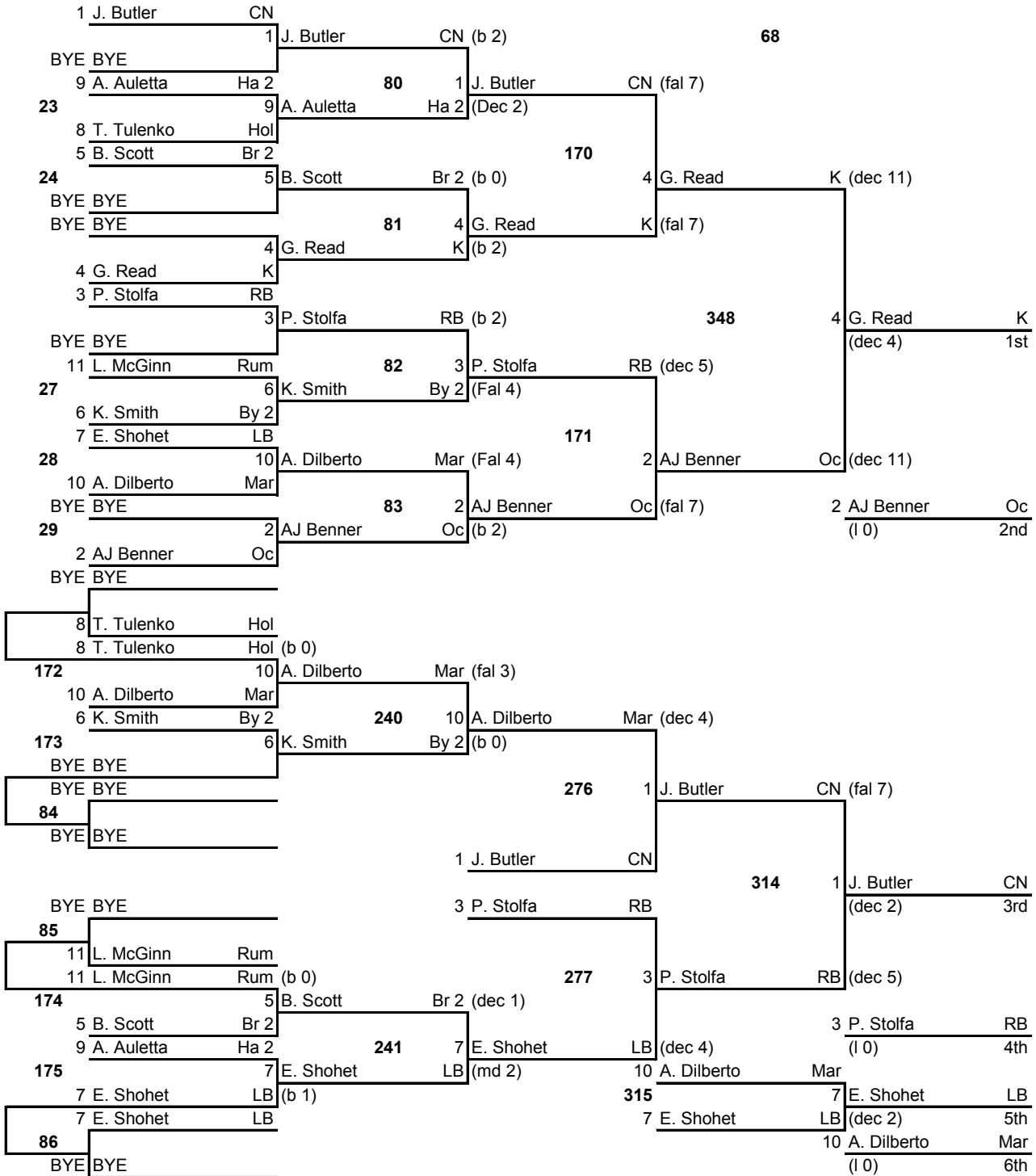

	1 S. Addison Rum					
	1 S. Addison Rum (b 2)			72		
BYE	BYE					
30	9 P. Dowd CN	87	1 S. Addison Rum (fal 7)			
	8 M. Pinnero Hol		(MD 3)			
	5 P. Mangano Ha 2			176		
31	12 R. Willis J 2		R. Willis J 2 (Dec 2)		1 S. Addison Rum (TF 12.5)	
32	13 L. Colleran By 2	88	4 C. Medvar K (MD 6)			
	4 C. Medvar K		(Fal 4)			
	3 I. Poppe Mat					
33	3 I. Poppe Mat (Fal 4)			349	1 S. Addison Rum (md 5) 1st	
14	R. Magliozi Mar					
34	11 A. Choback Br 2	89	3 I. Poppe Mat (fal 7)			
	6 N. Rivera Berk		(For 4)			
	7 T. Cochrane RB			177		
35	10 T. Kelleher LB		2 N. Benner Oc (fal 13)			
	10 T. Kelleher LB					
BYE	BYE	90	2 N. Benner Oc (MD 6)		2 N. Benner Oc (I 0) 2nd	
	2 N. Benner Oc (b 2)					
	2 N. Benner Oc					
	BYE					
	BYE					
	9 P. Dowd CN					
	9 P. Dowd CN (b 0)					
178	10 T. Kelleher LB (dec 1)					
	10 T. Kelleher LB					
179	11 A. Choback Br 2	242	10 T. Kelleher LB (dec 4)			
	5 P. Mangano Ha 2		(fal 3)			
	5 P. Mangano Ha 2 (dec 1)					
91	5 P. Mangano Ha 2			278	4 C. Medvar K (dec 5)	
	13 L. Colleran By 2					
			4 C. Medvar K			
	14 R. Magliozi Mar		3 I. Poppe Mat		316	3 I. Poppe Mat (TF 3.5) 3rd
92	6 N. Rivera Berk					
	14 R. Magliozi Mar (For 3)					
180	12 R. Willis J 2		3 I. Poppe Mat (fal 7)			
	12 R. Willis J 2					
181	8 M. Pinnero Hol	243	8 M. Pinnero Hol (fal 6)		4 C. Medvar K (I 0) 4th	
	8 M. Pinnero Hol (for 3)					
	7 T. Cochrane RB (b 0)		10 T. Kelleher LB			
	7 T. Cochrane RB			317	8 M. Pinnero Hol (Fal 4) 5th	
	BYE				10 T. Kelleher LB (I 0) 6th	
	BYE					

	1 S. Rotondella	K		1 S. Rotondella	K (b 2)		76	
	BYE	BYE						
36	9 A. Ciccone	RB	93	1 S. Rotondella	K (fal 7)			
	8 T. Distefano	By 2		9 A. Ciccone	RB (Dec 2)			
	5 M. Garber	CN				182		
37	12 C. Bailey	Ha 2		5 M. Garber	CN (Dec 2)			1 S. Rotondella K (fal 13)
	13 A. Parikh	J 2	94	5 M. Garber	CN (dec 5)			
37.1	4 D. Ryan	Mar		4 D. Ryan	Mar (For 4)			
	3 M. Brignola	Rum						
37.2	14 D. Rotolo	Mat		3 M. Brignola	Rum (For 4)		350	1 S. Rotondella K (dec 4) 1st
	11 J. Cox	Berk	95	3 M. Brignola	Rum (fal 7)			
38	6 T. Ferris	Br 2		6 T. Ferris	Br 2 (TF 3.5)			
	7 N. Ammirati	Hol				183		
39	10 J. Conlon	LB		10 J. Conlon	LB (Fal 4)			2 J. Nies Oc (dec 11)
	BYE	BYE	96	2 J. Nies	Oc (MD 6)			2 J. Nies Oc (l 0) 2nd
	2 J. Nies	Oc		2 J. Nies	Oc (b 2)			
	BYE	BYE						
	8 T. Distefano	By 2						
	8 T. Distefano	By 2	(b 0)					
184	10 J. Conlon	LB		10 J. Conlon	LB (dec 1)			
	6 T. Ferris	Br 2	244	6 T. Ferris	Br 2 (MD 5)			
185	6 T. Ferris	Br 2		6 T. Ferris	Br 2 (dec 1)			
	12 C. Bailey	Ha 2	(For 3)					
	12 C. Bailey	Ha 2				280		5 M. Garber CN (MD 6)
	13 A. Parikh	J 2						
				5 M. Garber	CN			
	14 D. Rotolo	Mat		3 M. Brignola	Rum		318	3 M. Brignola Rum (dec 2) 3rd
	11 J. Cox	Berk						
	11 J. Cox	Berk	(For 3)			281		3 M. Brignola Rum (dec 5)
186	4 D. Ryan	Mar		4 D. Ryan	Mar (fal 3)			
	9 A. Ciccone	RB	245	4 D. Ryan	Mar (dec 4)			5 M. Garber CN (l 0) 4th
187	7 N. Ammirati	Hol		7 N. Ammirati	Hol (TF 2.5)			6 T. Ferris Br 2
	7 N. Ammirati	Hol	(b 1)			319		4 D. Ryan Mar (fal 4) 5th
	BYE	BYE						6 T. Ferris Br 2 (l 0) 6th

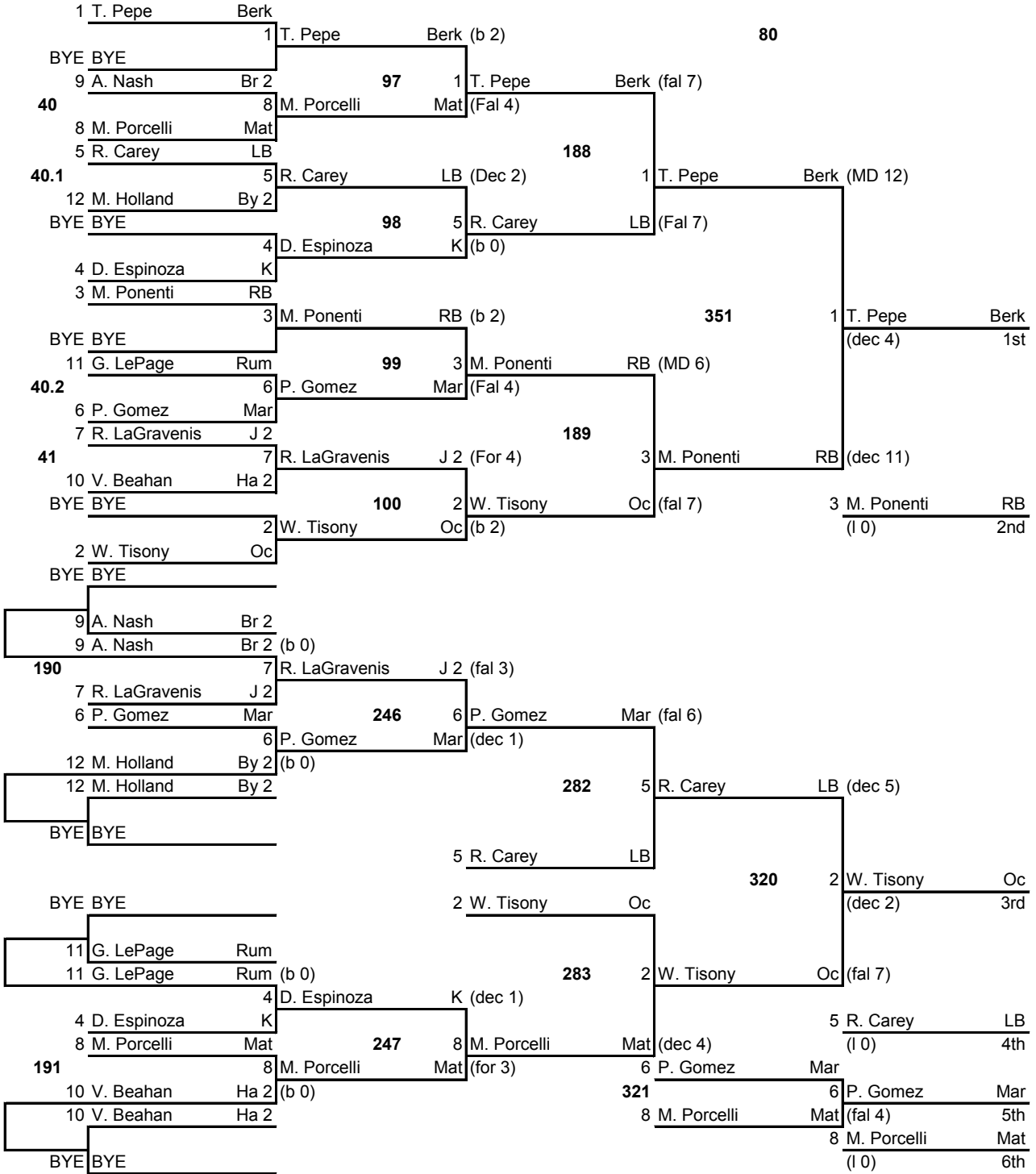

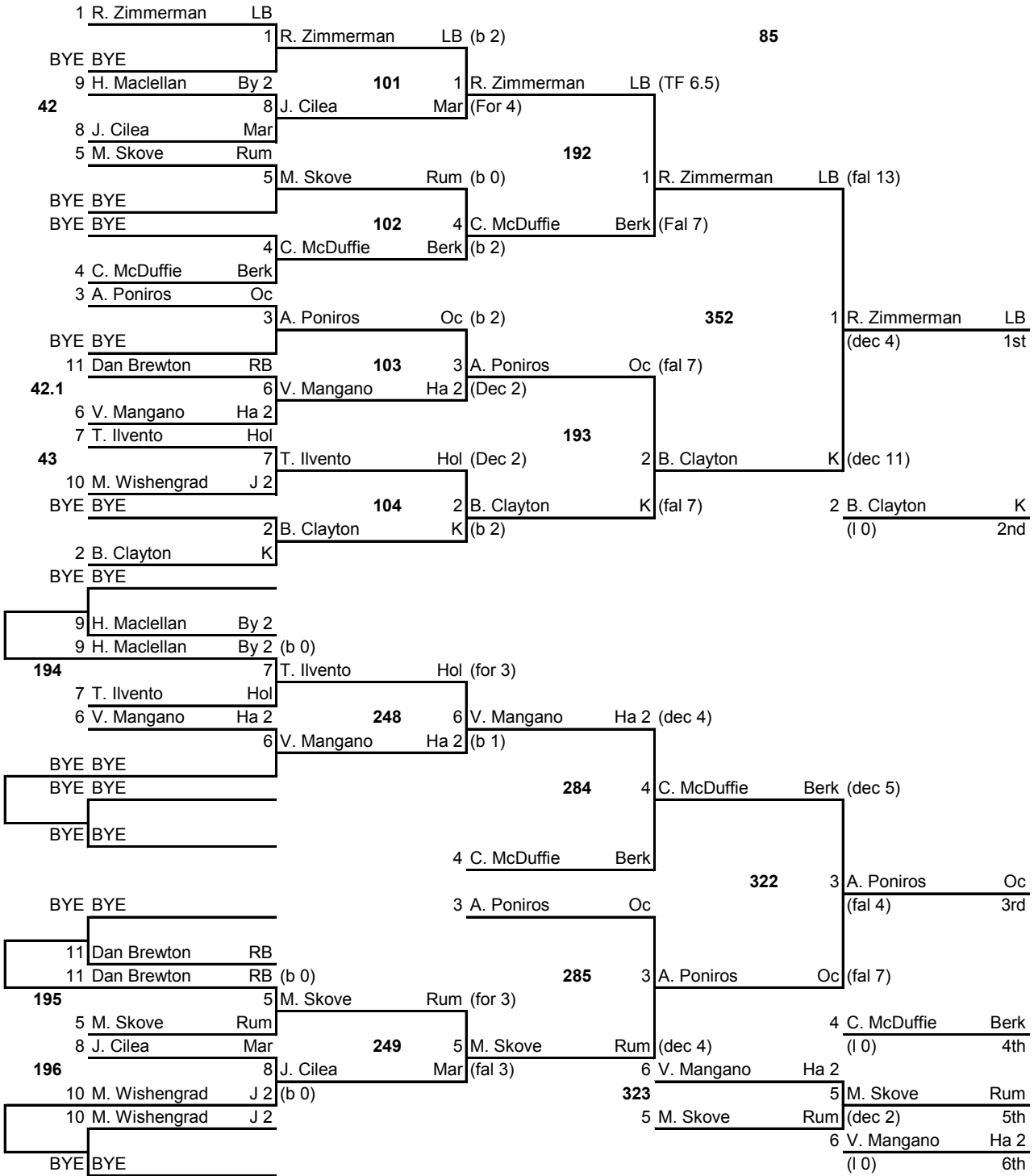

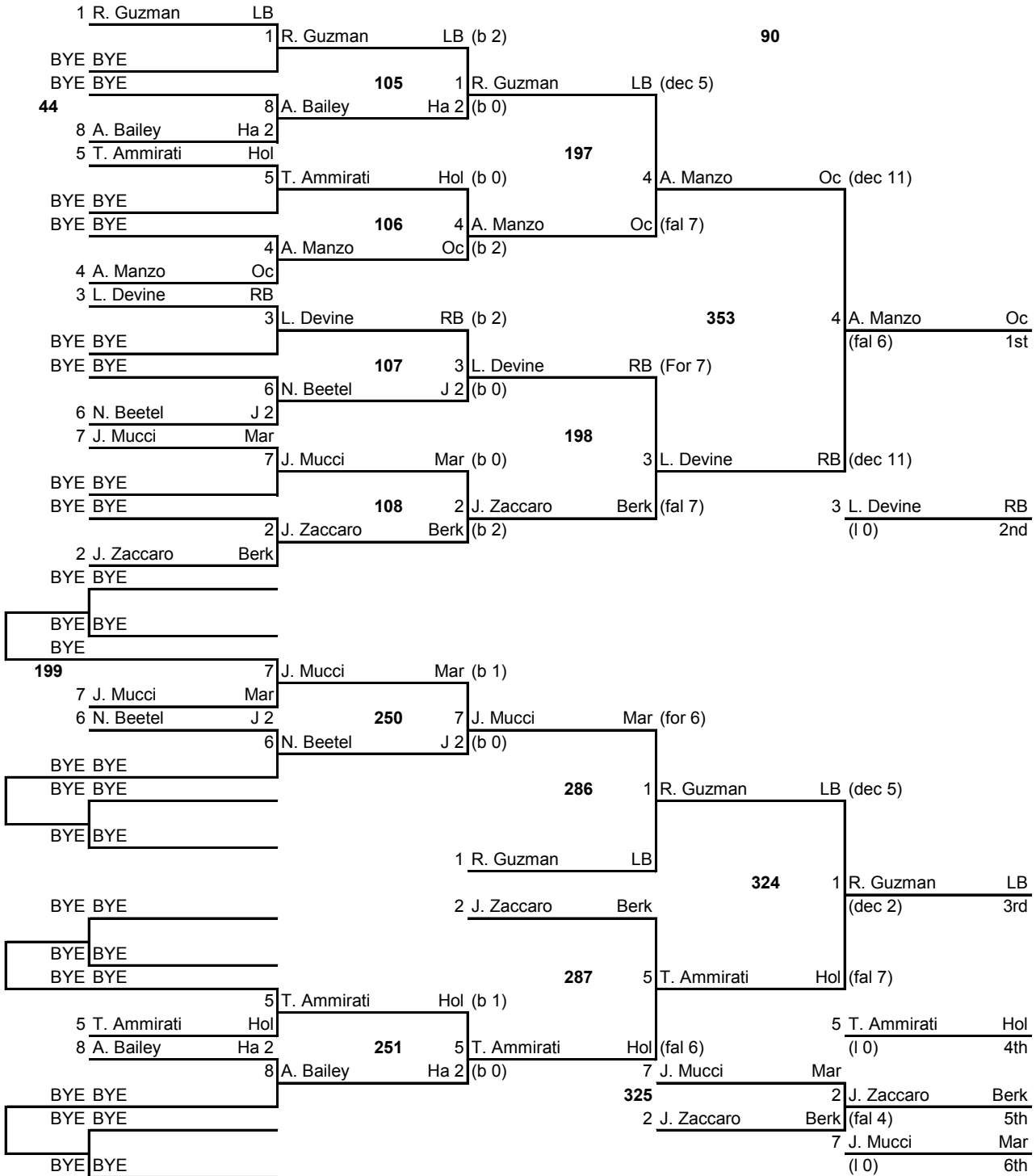

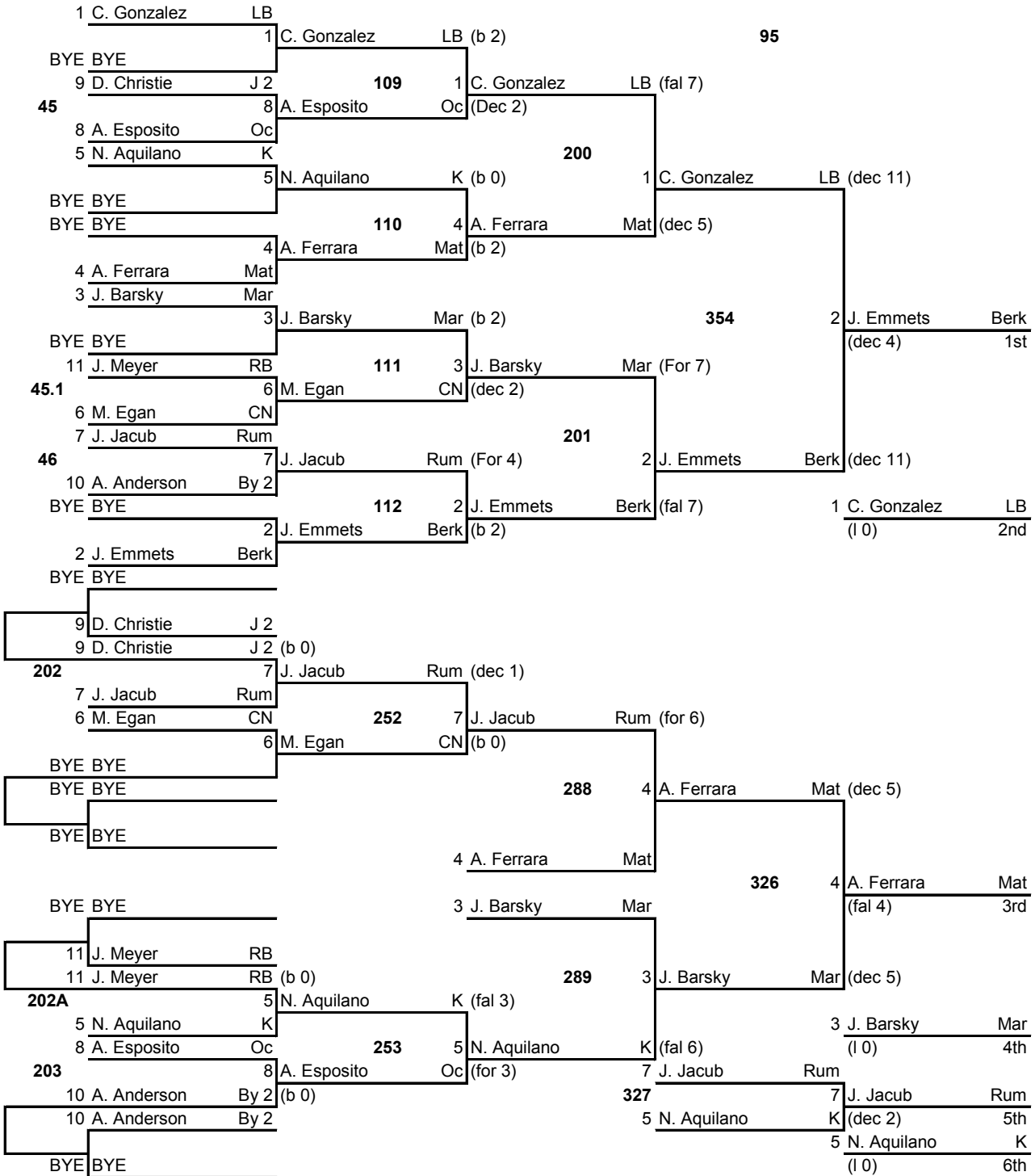

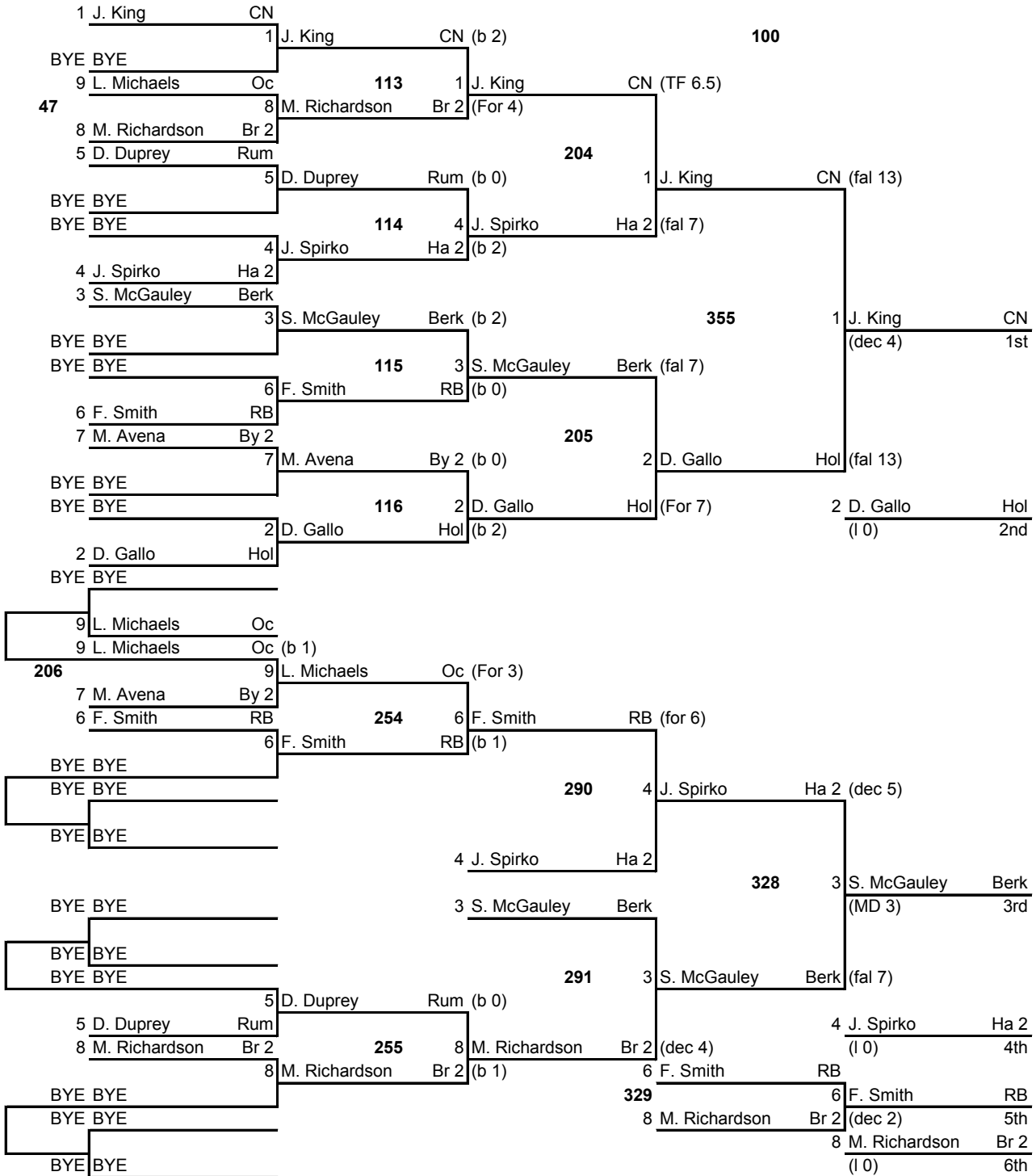

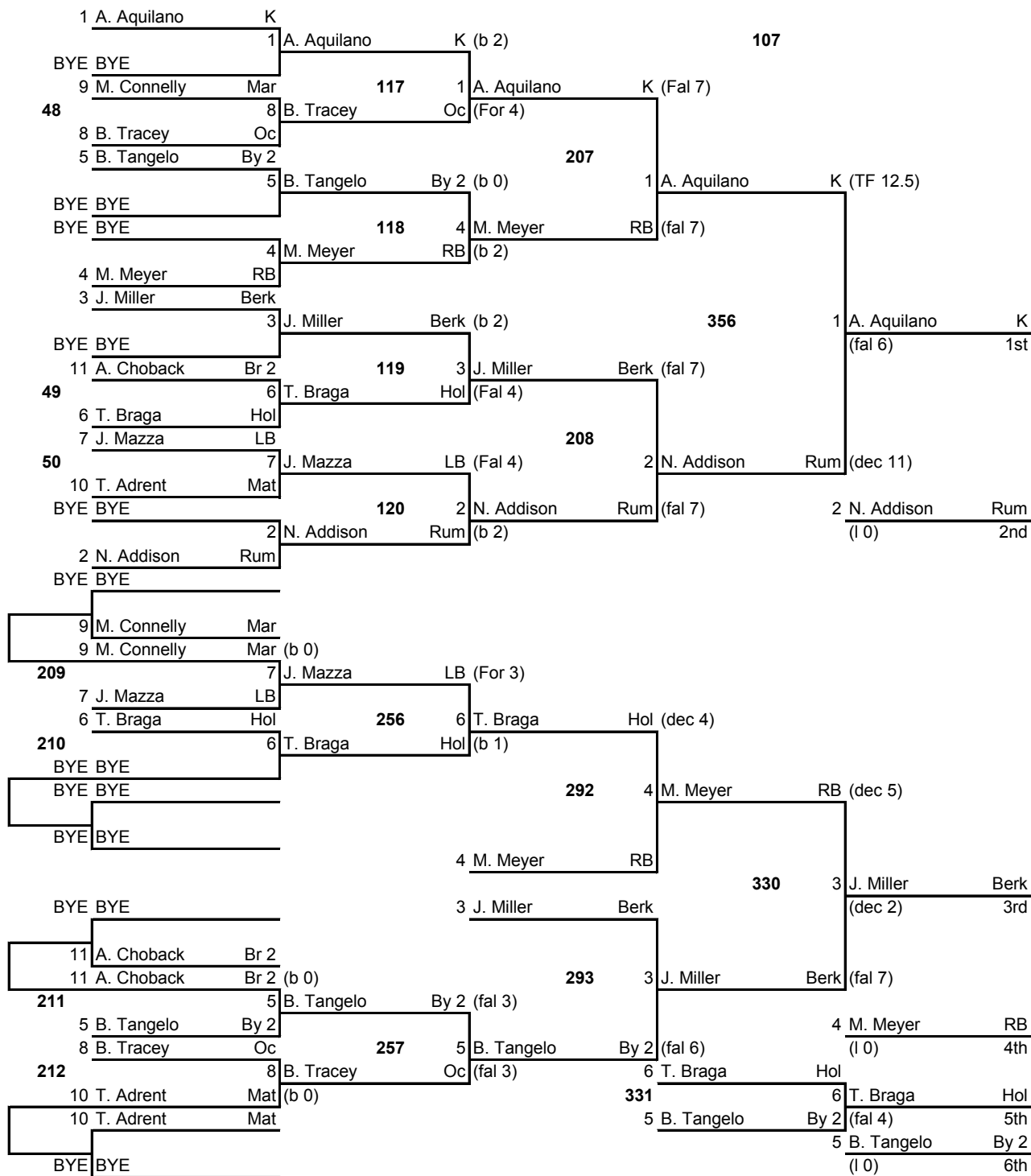

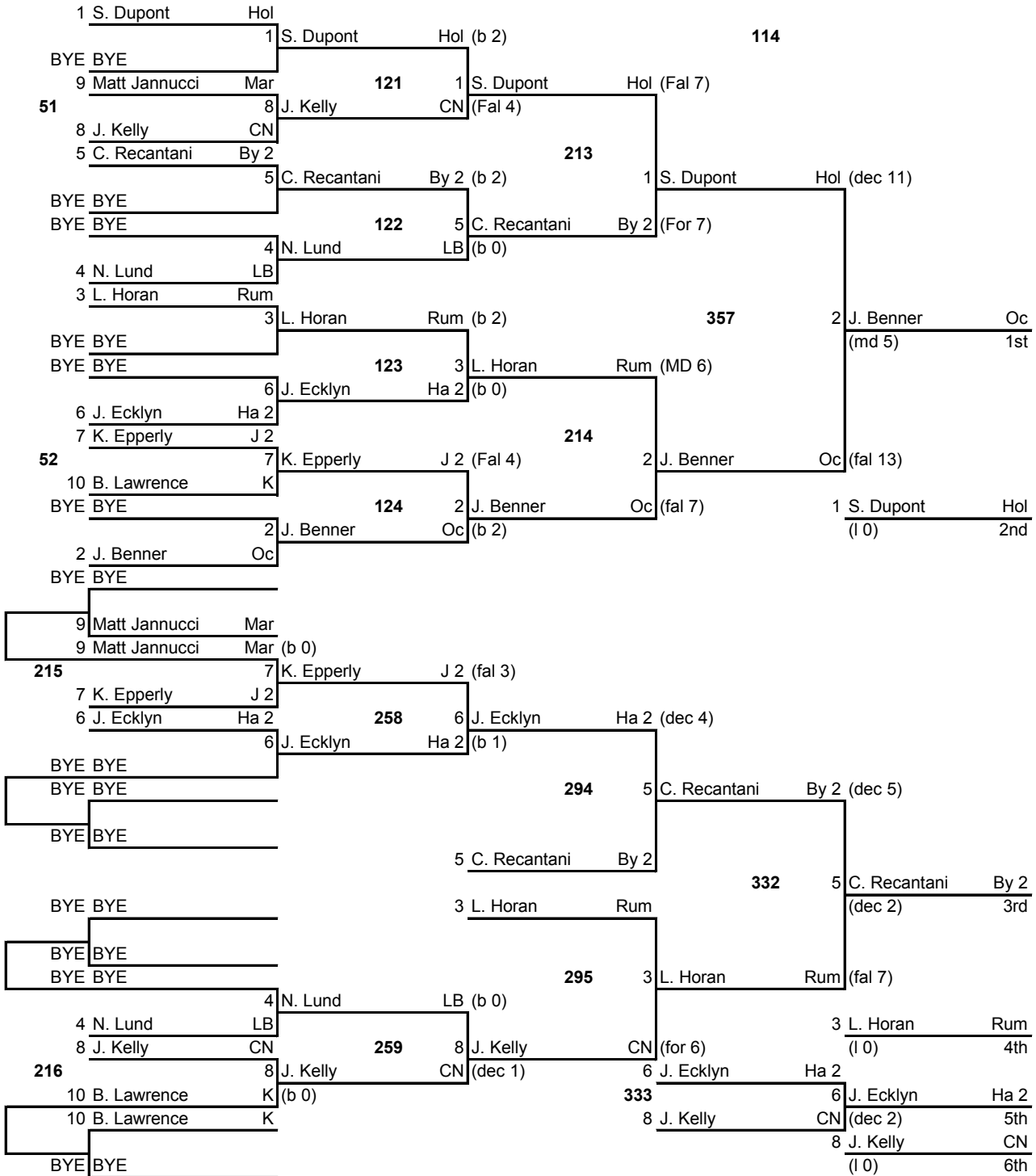

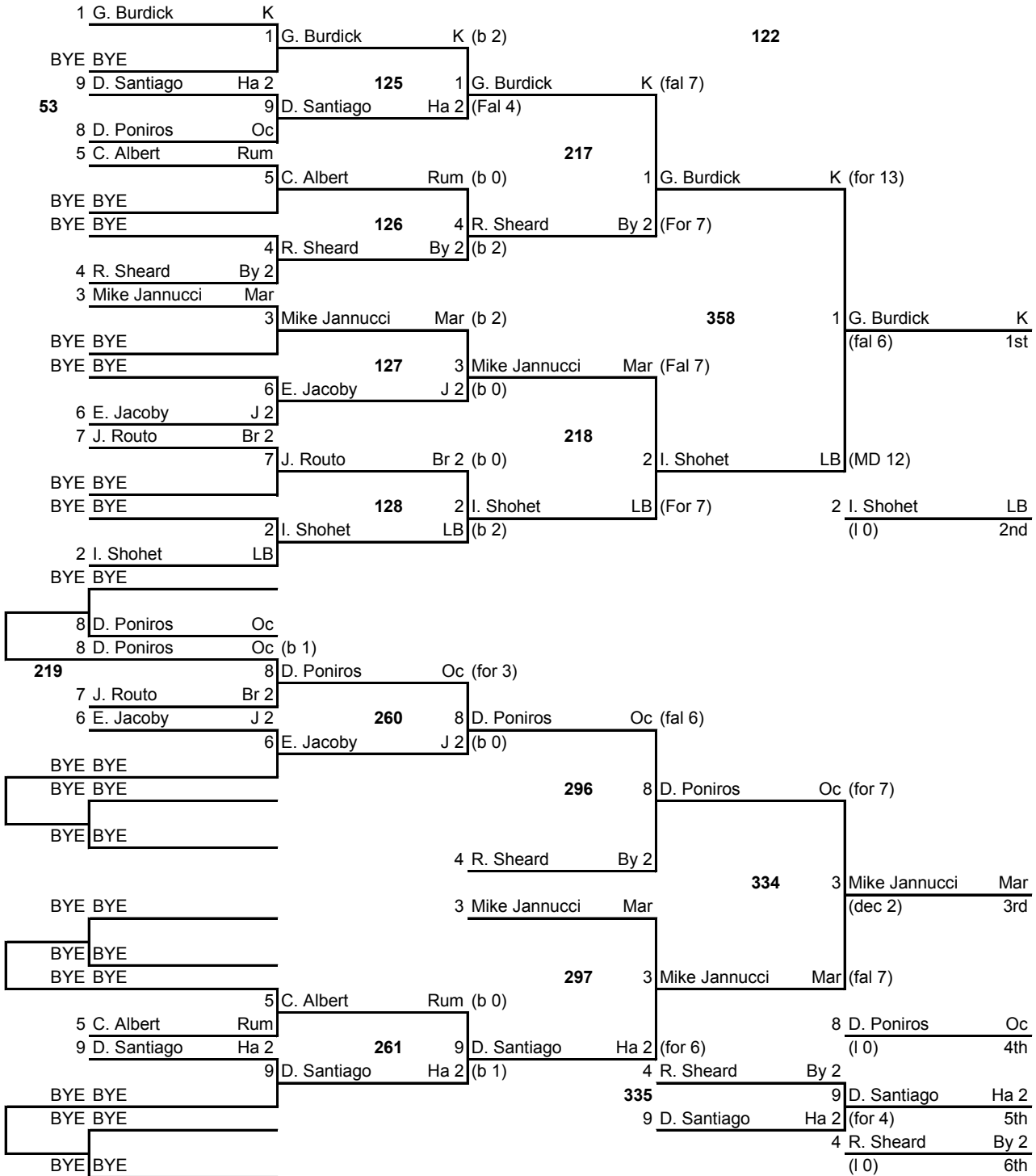

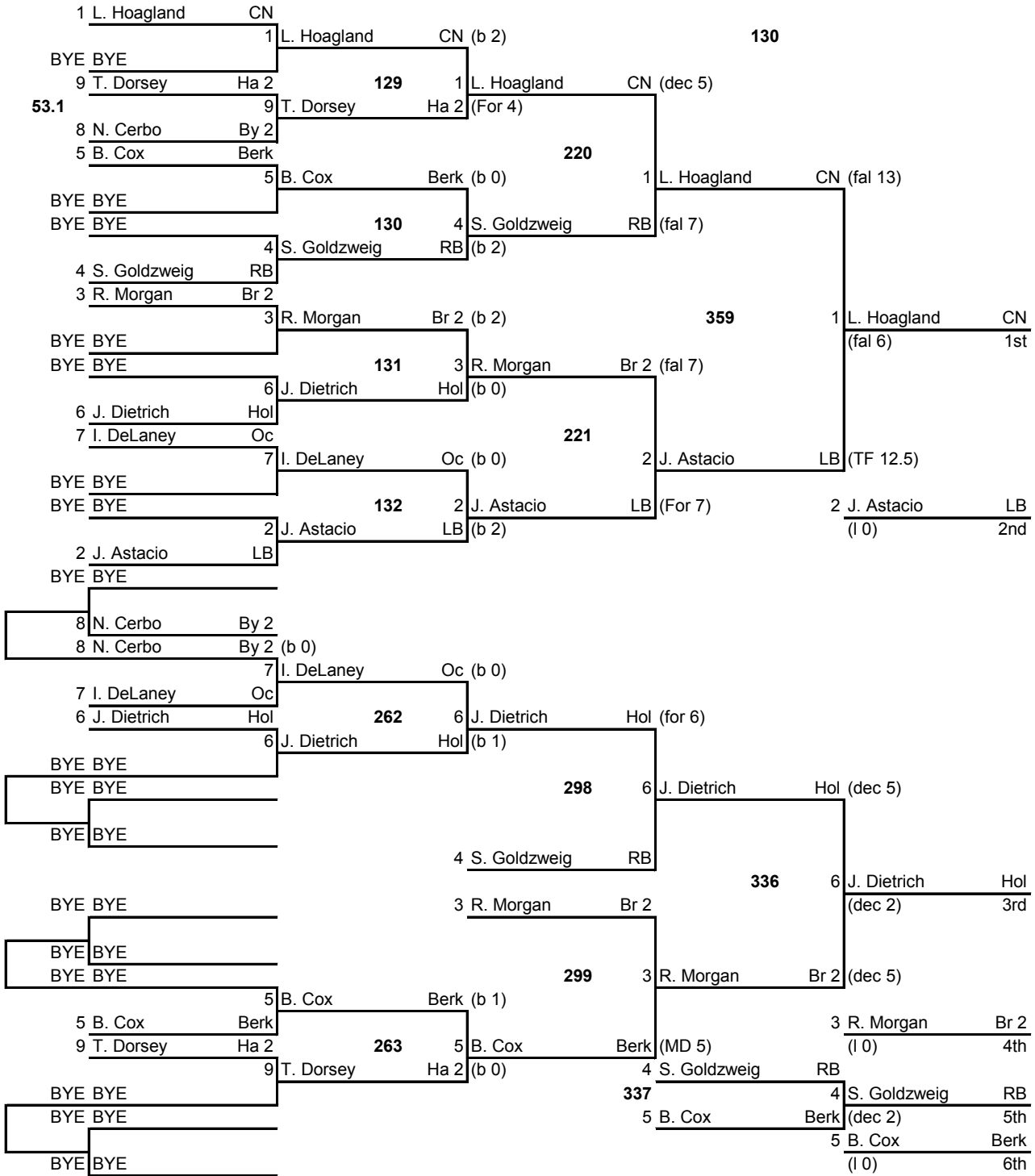

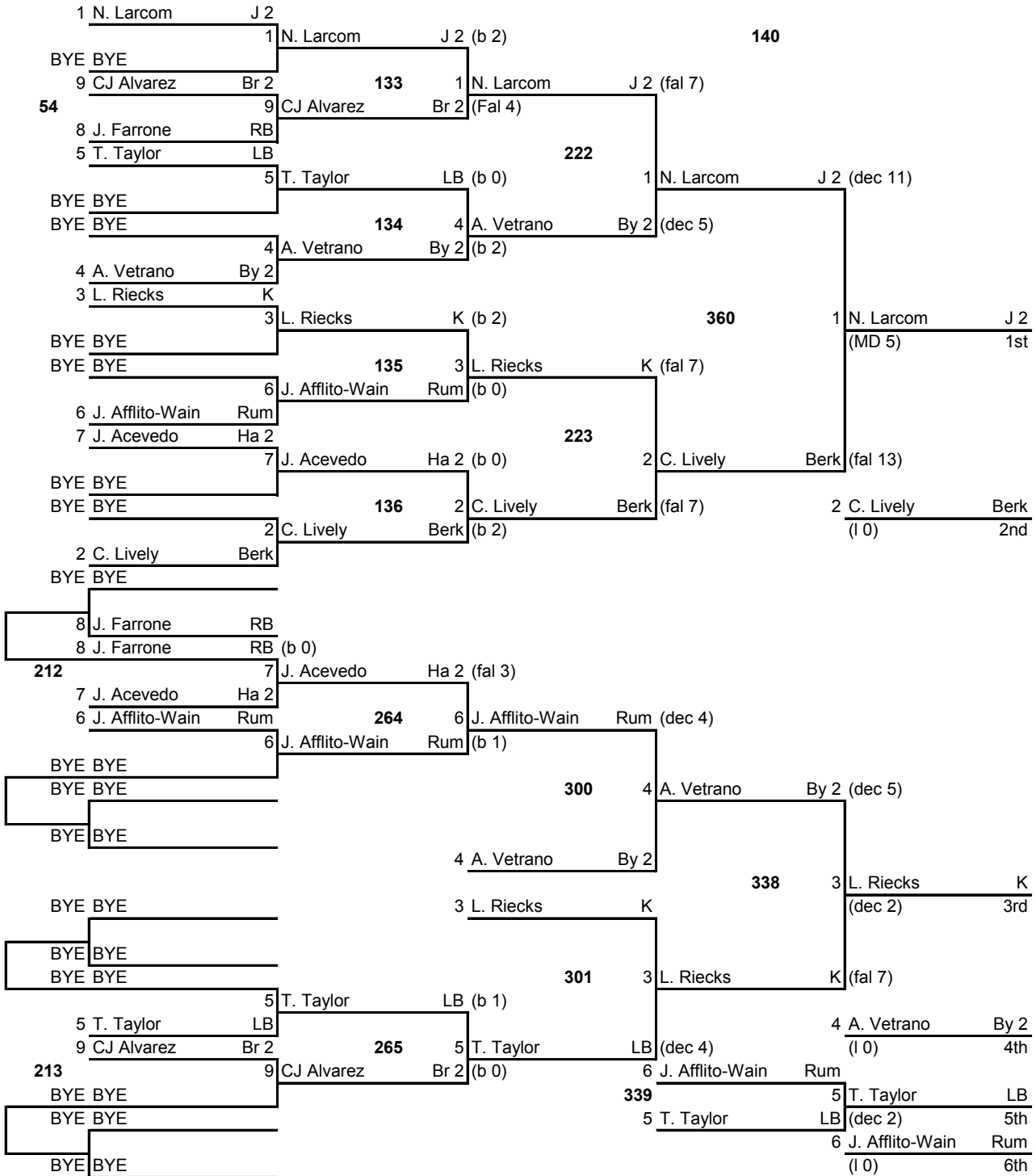

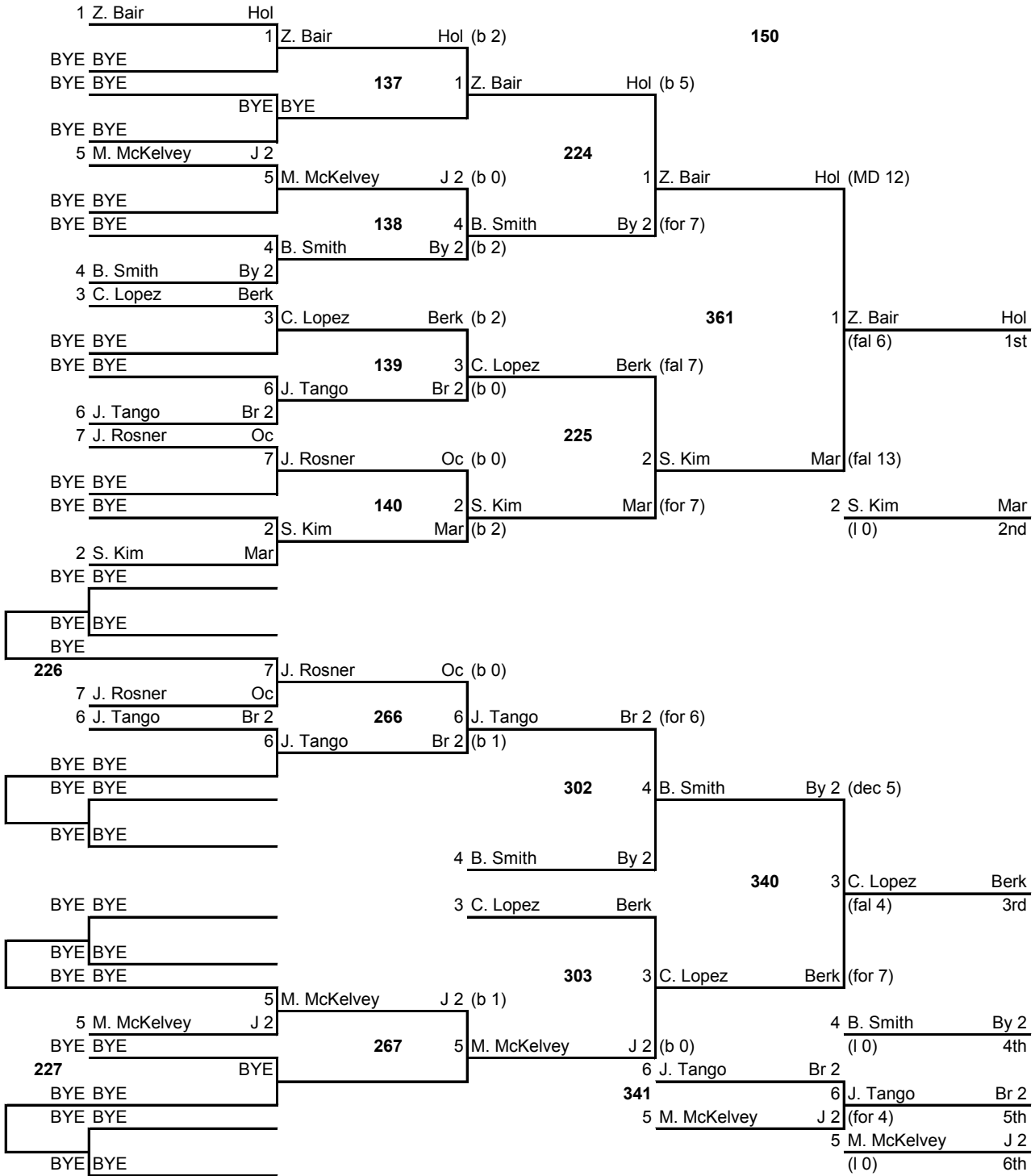

1 M. Coelho Berk								
BYE BYE	1 M. Coelho Berk (b 2)			HWT				
9 M. Spirko Ha 2	141	1 M. Coelho Berk (fal 7)						
54.1	9 M. Spirko Ha 2 (Fal 4)							
8 B. Galassi J 2								
5 B. Lawrence Mar		228						
BYE BYE	5 B. Lawrence Mar (b 0)		1 M. Coelho Berk (fal 13)					
BYE BYE	142	4 J. Hardowitz By 2 (For 7)						
4 J. Hardowitz By 2	4 J. Hardowitz By 2 (b 2)							
3 P. Liseno K								
BYE BYE	3 P. Liseno K (b 0)		362					
BYE BYE	143	6 P. Wersinger LB (fal 7)	1 M. Coelho Berk (fal 6)					1st
6 P. Wersinger LB	6 P. Wersinger LB (b 2)							
7 J. Fontanella Rum		229						
BYE BYE	7 J. Fontanella Rum (b 0)		2 TJ DiMario CN (fal 13)					
BYE BYE	144	2 TJ DiMario CN (fal 7)						
2 TJ DiMario CN	2 TJ DiMario CN (b 2)		2 TJ DiMario CN (l 0)					2nd
BYE BYE								
8 B. Galassi J 2								
8 B. Galassi J 2 (b 0)								
7 J. Fontanella Rum	7 J. Fontanella Rum (fal 3)							
3 P. Liseno K		3 P. Liseno K (dec 4)						
BYE BYE	3 P. Liseno K (b 1)							
BYE BYE								
BYE BYE		4 J. Hardowitz By 2 (dec 5)						
BYE BYE								
BYE BYE		4 J. Hardowitz By 2						
BYE BYE								
BYE BYE		6 P. Wersinger LB	342					
BYE BYE			6 P. Wersinger LB (fal 4)					3rd
BYE BYE								
BYE BYE		304	6 P. Wersinger LB (dec 5)					
5 B. Lawrence Mar	5 B. Lawrence Mar (b 0)							
9 M. Spirko Ha 2		9 M. Spirko Ha 2 (for 6)	4 J. Hardowitz By 2 (l 0)					4th
BYE BYE	9 M. Spirko Ha 2 (b 1)							
BYE BYE		3 P. Liseno K						
BYE BYE								
BYE BYE		9 M. Spirko Ha 2 (MD 3)	3 P. Liseno K					5th
BYE BYE			9 M. Spirko Ha 2 (l 0)					6th

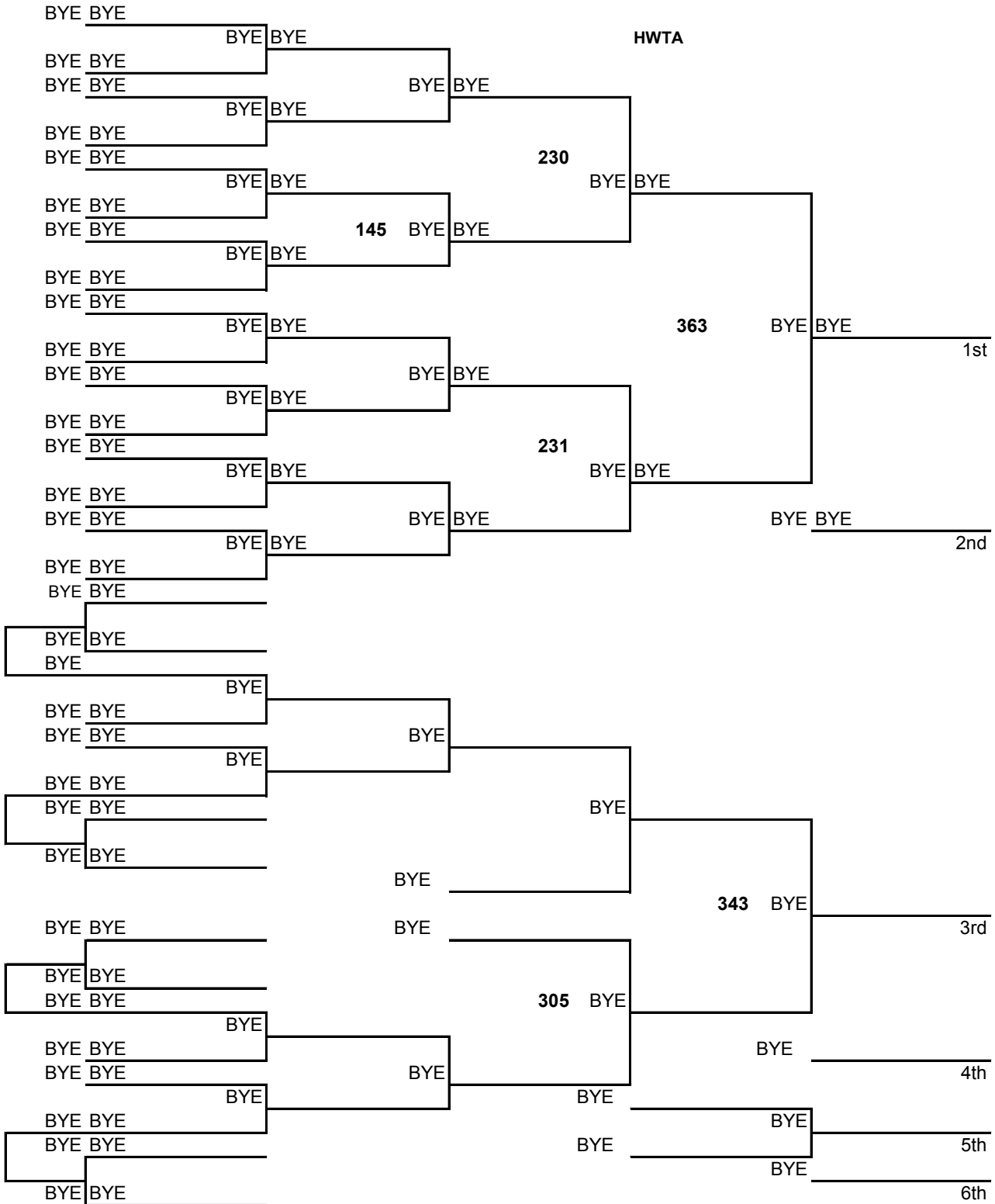

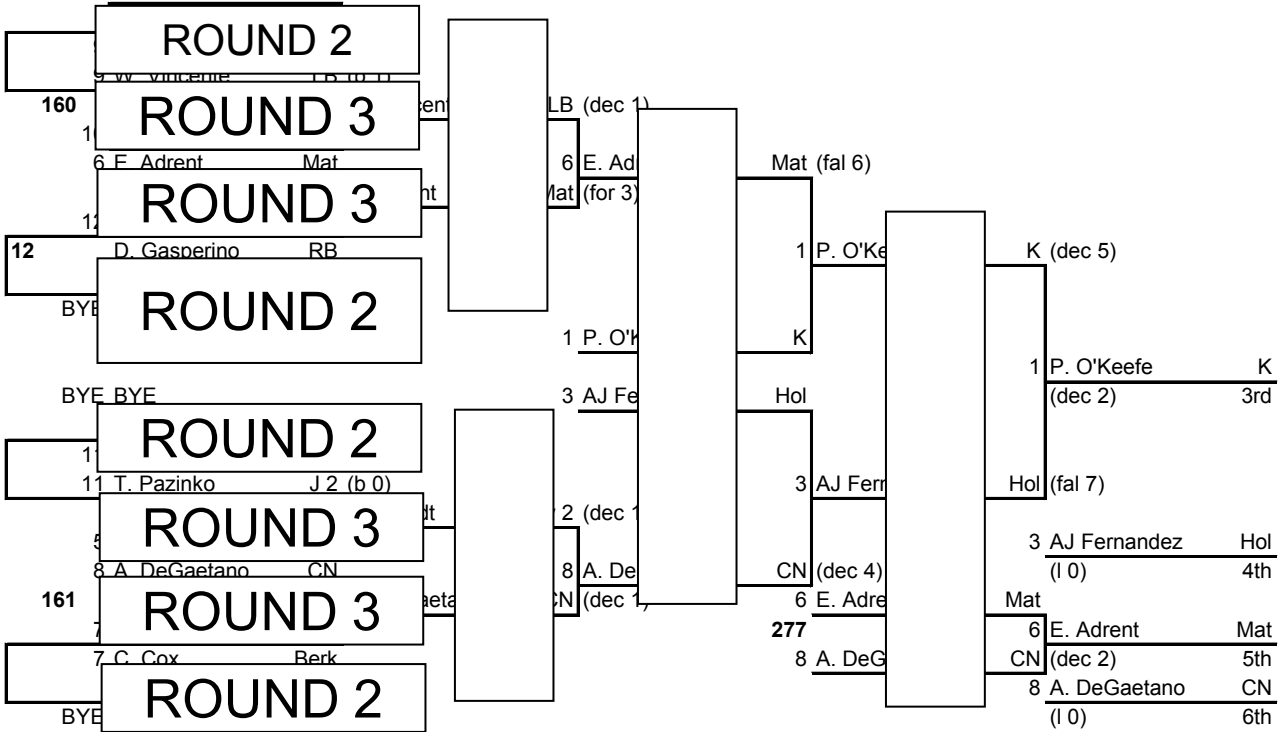
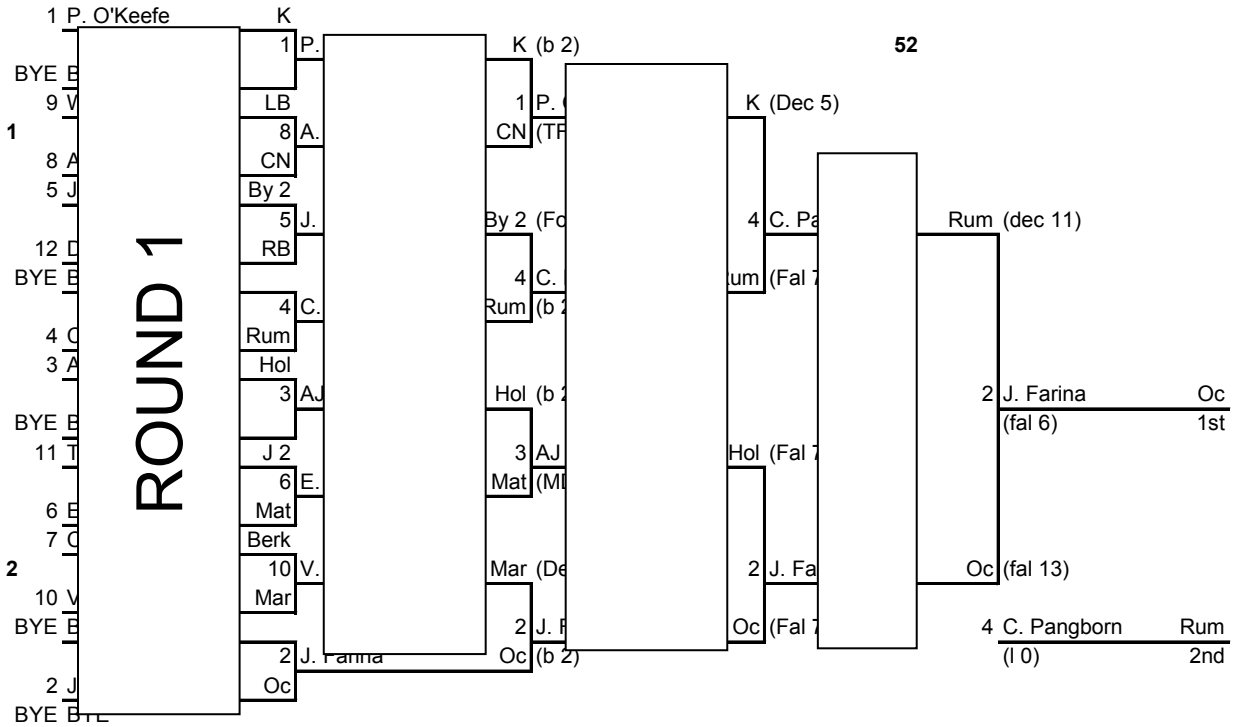

Score	Team
271	Oc
219.5	K
204	Berk
180	LB
161.5	Hol
146	CN
143.5	Rum
134	Mar
128	Mat
125	RB
86	Ha 2
83	By 2
61.5	Br 2
51	J 2